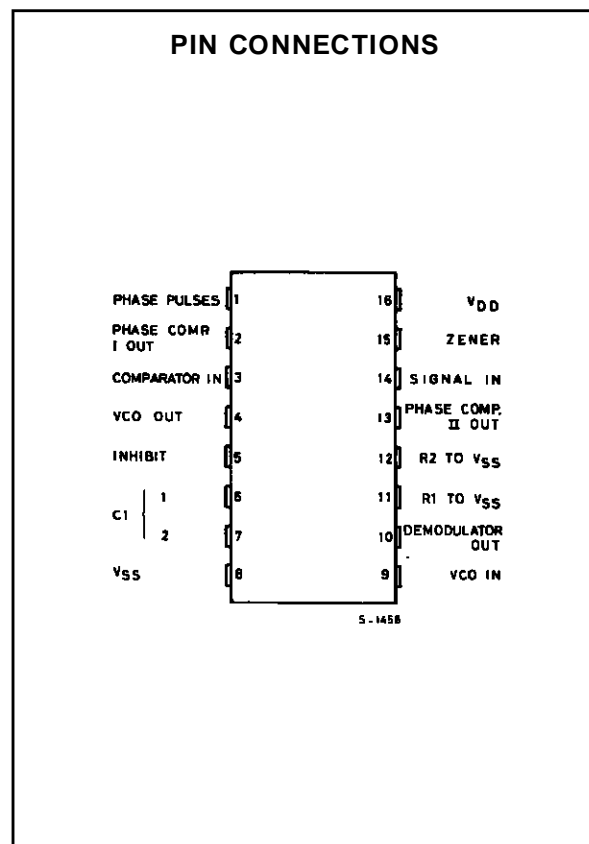
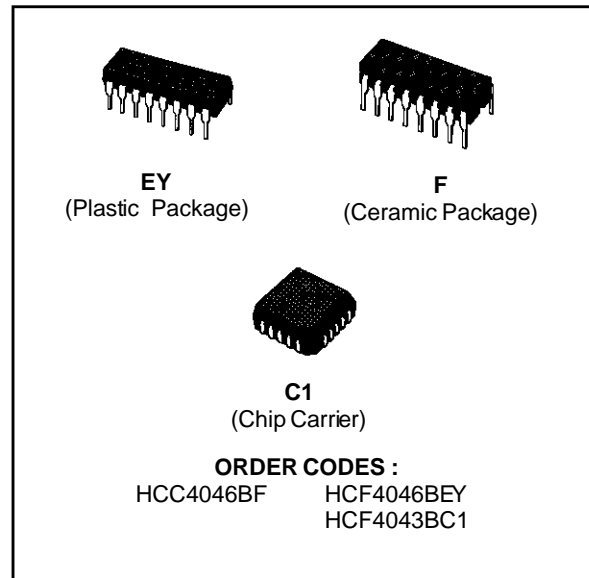


**MICROPOWER PHASE-LOCKED LOOP**

- QUIESCENT CURRENT SPECIFIED TO 20V FOR HCC DEVICE
- VERY LOW POWER CONSUMPTION : 100µW (TYP.) AT VCO  $f_o = 10\text{kHz}$ ,  $V_{DD} = 5\text{V}$
- OPERATING FREQUENCY RANGE : UP TO 1.4MHz (TYP.) AT  $V_{DD} = 10\text{V}$
- LOW FREQUENCY DRIFT : 0.06%/°C (typ.) AT  $V_{DD} = 10\text{V}$
- CHOICE OF TWO PHASE COMPARATORS :
  - 1) EXCLUSIVE - OR NETWORK
  - 2) EDGE-CONTROLLED MEMORY NETWORK WITH PHASE-PULSE OUTPUT FOR LOCK INDICATION
- HIGH VCO LINEARITY : 1% (TYP.)
- VCO INHIBIT CONTROL FOR ON-OFF KEYING AND ULTRA-LOW STANDBY POWER CONSUMPTION
- SOURCE-FOLLOWER OUTPUT OF VCO CONTROL INPUT (demod. output)
- ZENER DIODE TO ASSIST SUPPLY REGULATION
- 5V, 10V AND 15V PARAMETRIC RATING
- INPUT CURRENT OF 100nA AT 18V AND 25°C FOR HCC DEVICE
- 100% TESTED FOR QUIESCENT CURRENT
- MEETS ALL REQUIREMENTS OF JEDEC TENTATIVE STANDARD N°. 13A, "STANDARD SPECIFICATIONS FOR DESCRIPTION OF "B" SERIES CMOS DEVICES"

**DESCRIPTION**

The **HCC4046B** (extended temperature range) and **HCF4046B** (intermediate temperature range) are monolithic integrated circuits, available in 16-lead dual in-line plastic or ceramic package. The **HCC/HCF4046B** COS/MOS Micropower Phase-Locked Loop (PLL) consists of a low-power, linear voltage-controlled oscillator (VCO) and two different phase comparators having a common signal-input amplifier and a common comparator input. A 5.2V zener diode is provided for supply regulation if necessary.



### VCO Section

The VCO requires one external capacitor C1 and one or two external resistors (R1 or R1 and R2). Resistor R1 and capacitor C1 determine the frequency range of the VCO and resistor R2 enables the VCO to have a frequency offset if required. The high input impedance ( $10^{12}\Omega$ ) of the VCO simplifies the design of low-pass filters by permitting the designer a wide choice of resistor-to-capacitor ratios. In order not to load the low-pass filter, a source-follower output of the VCO input voltage is provided at terminal 10 (DE-MODULATED OUTPUT). If this terminal is used, a load resistor (Rs) of 10 k $\Omega$  or more should be connected from this terminal to Vss. If unused this terminal should be left open. The VCO can be connected either directly or through frequency dividers to the comparator input of the phase comparators. A full COS/MOS logic swing is available at the output of the VCO and allows direct coupling to COS/MOS frequency dividers such as the **HCC/HCF4024B**, **HCC/HCF4018B**, **HCC/HCF4020B**, **HCC/HCF4022B**, **HCC/HCF4029B**, and **HBC/HBF4059A**. One or more **HCC/HCF4018B** (Presetable Divide-by-N Counter) or **HCC/HCF4029B** (Presetable Up/Down Counter), or **HBC/HBF4059A** (Programmable Divide-by-"N" Counter), together with the **HCC/HCF4046B** (Phase-Locked Loop) can be used to build a micropower low-frequency synthesizer. A logic 0 on the INHIBIT input "enables" the VCO and the source follower, while a logic 1 "turns off" both to minimize stand-by power consumption.

### Phase Comparators

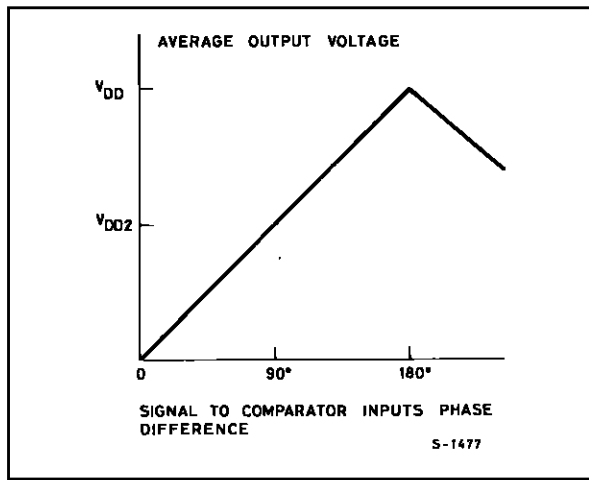
The phase-comparator signal input (terminal 14) can be direct-coupled provided the signal swing is within COS/MOS logic levels [logic "0"  $\leq 30\%$  ( $V_{DD} - V_{SS}$ ), logic "1"  $\geq 70\%$  ( $V_{DD} - V_{SS}$ )]. For smaller swings the signal must be capacitively coupled to the self-biasing amplifier at the signal input. Phase comparator I is an exclusive-OR network; it operates analogously to an over-driven balanced mixer. To maximize the lock range, the signal and comparator-input frequencies must have a 50% duty cycle. With no signal or noise on the signal input, this phase comparator has an average output voltage equal to  $V_{DD}/2$ . The low-pass filter connected to the output of phase comparator I supplies the averaged voltage to the VCO input, and causes the VCO to oscillate at the center frequency ( $f_0$ ). The frequency range of input signals on which the PLL will lock if it was initially out of lock is defined as the frequency capture range ( $2f_0$ ). The frequency range of input signals on which the loop will stay locked if it was initially in lock is defined as the frequency lock range ( $2f_L$ ). The capture range is  $\leq$  the

lock range. With phase comparator I the range of frequencies over which the PLL can acquire lock (capture range) is dependent on the low-pass-filter characteristics, and can be made as large as the lock range. Phase-comparator I enables a PLL system to remain in lock in spite of high amounts of noise in the input signal. One characteristic of this type of phase comparator is that it may lock onto input frequencies that are close to harmonics of the VCO center-frequency. A second characteristic is that the phase angle between the signal and the comparator input varies between  $0^\circ$  and  $180^\circ$ , and is  $90^\circ$  at the center frequency. Fig. (a) shows the typical, triangular, phase-to-output response characteristic of phase-comparator I. Typical waveforms for a COS/MOS phase-locked-loop employing phase comparator I in locked condition of  $f_0$  is shown in fig. (b). Phase-comparator II is an edge-controlled digital memory network. It consists of four flip-flop stages, control gating, and a three-stage output-circuit comprising p- and n-type drivers having a common output node. When the p-MOS or n-MOS drivers are ON they pull the output up to  $V_{DD}$  or down to  $V_{SS}$ , respectively. This type of phase comparator acts only on the positive edges of the signal and comparator inputs. The duty cycles of the signal and comparator inputs are not important since positive transitions control the PLL system utilizing this type of comparator. If the signal-input frequency is higher than the comparator-input frequency, the p-type output driver is maintained ON most of the time, and both the n- and p-drivers OFF (3 state) the remainder of the time. If the signal-input frequency is lower than the comparator-input frequency, the n-type output driver is maintained ON most of the time, and both the n- and p-drivers OFF (3 state) the remainder of the time. If the signal and comparator-input frequencies are the same, but the signal input lags the comparator input in phase, the n-type output driver is maintained ON for a time corresponding to the phase difference. If the signal and comparator-input frequencies are the same, but the comparator input lags the signal in phase, the p-type output driver is maintained ON for a time corresponding to the phase difference. Subsequently, the capacitor voltage of the low-pass filter connected to this phase comparator is adjusted until the signal and comparator inputs are equal in both phase and frequency. At this stable point both p- and n-type output drivers remain OFF and thus the phase comparator output becomes an open circuit and holds the voltage on the capacitor of the low-pass filter constant. Moreover the signal at the "phase pulses" output is a high level which can be used for indicating a locked condition. Thus, for phase comparator II, no phase difference exists between signal and comparator

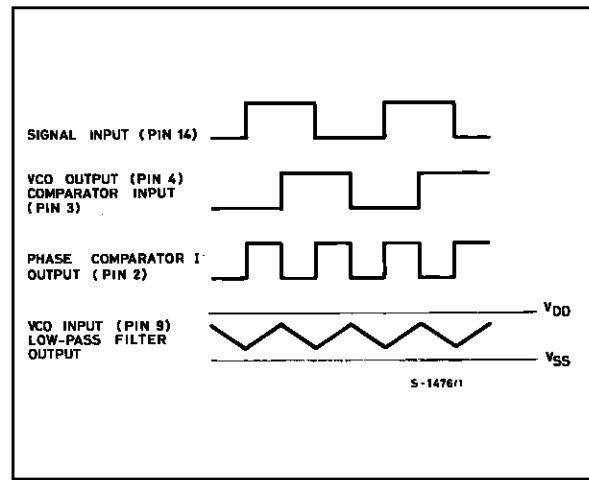
input over the full VCO frequency range. Moreover, the power dissipation due to the low-pass filter is reduced when this type of phase comparator is used because both the p- and n-type output drivers are OFF for most of the signal input cycle. It should be noted that the PLL lock range for this type of phase

comparator is equal to the capture range, independent of the low-pass filter. With no signal present at the signal input, the VCO is adjusted to its lowest frequency for phase comparator II. Fig. (c) shows typical waveforms for a COS/MOS PLL employing phase comparator II in a locked condition.

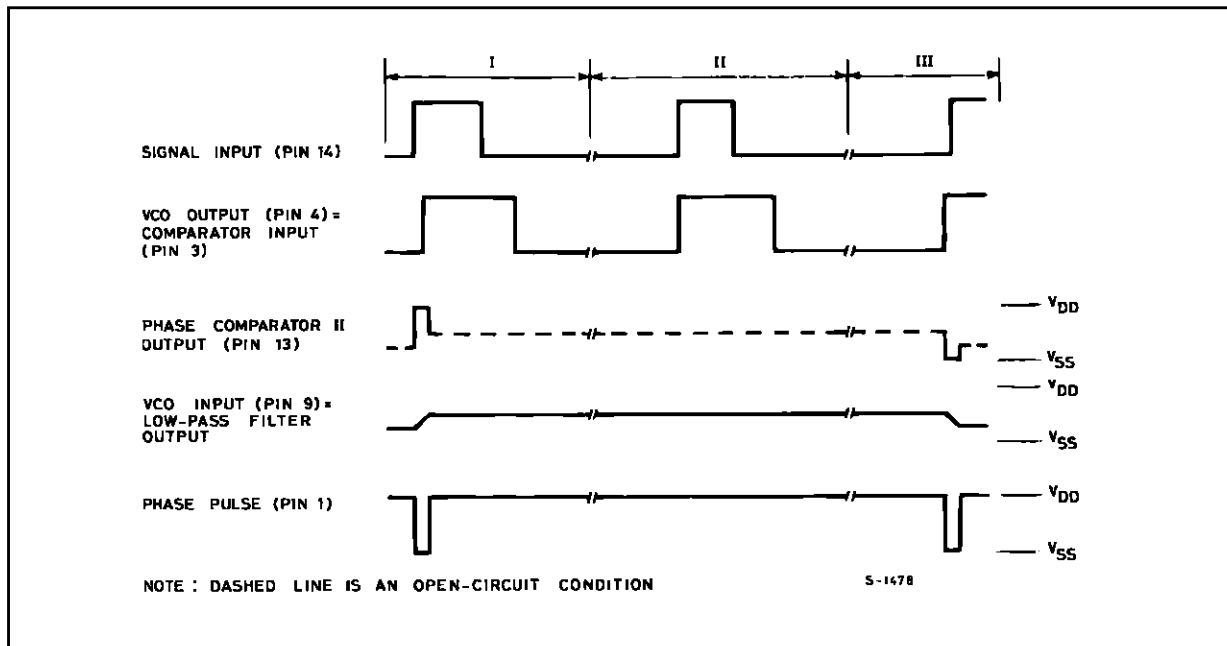
**Figure a :** Phase-Comparator I Characteristics at Low-Pass Filter Output.



**Figure b :** Typical Waveforms for COS/MOS Phase Locked-Loop Employing Phase Comparator I in Locked Condition of  $f_0$ .

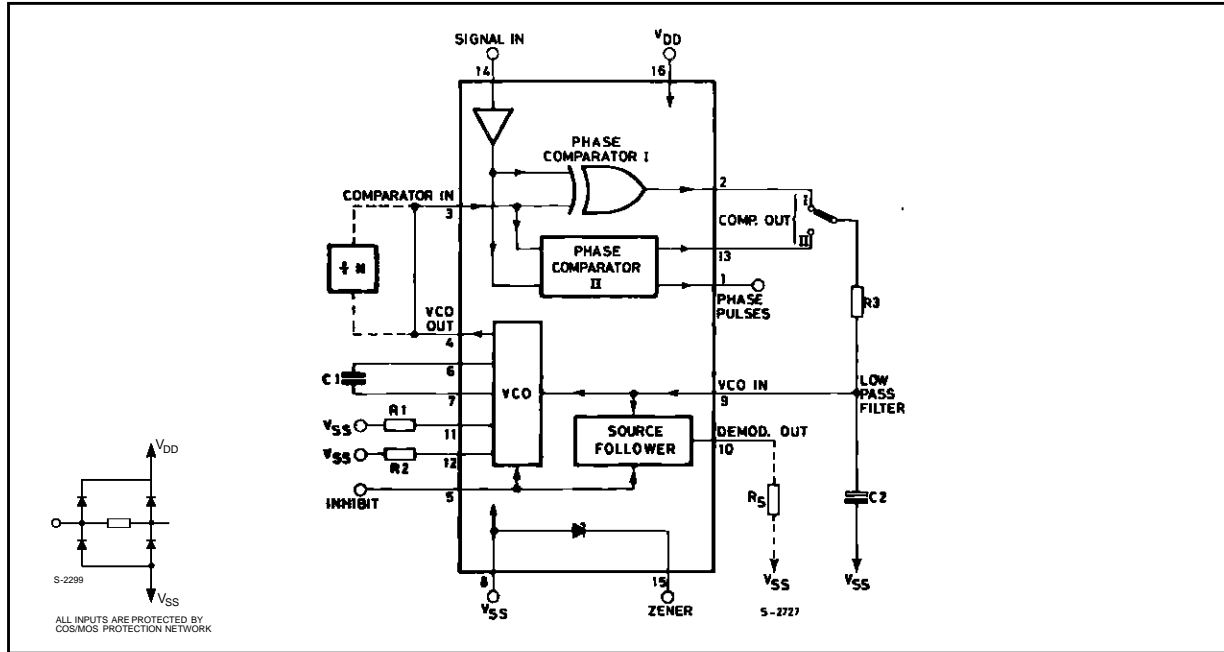


**Figure C :** Typical Waveforms For COS/MOS Phase-locked Loop Employing Phase Comparator II In Locked Condition.



# HCC/HCF4046B

## FUNCTIONAL DIAGRAM



## ABSOLUTE MAXIMUM RATINGS

Symbol	Parameter	Value	Unit
$V_{DD}^*$	Supply Voltage : HCC Types HCF Types	- 0.5 to + 20 - 0.5 to + 18	V
$V_i$	Input Voltage	- 0.5 to $V_{DD} + 0.5$	V
$I_i$	DC Input Current (any one input)	$\pm 10$	mA
$P_{tot}$	Total Power Dissipation (per package) Dissipation per Output Transistor for $T_{op}$ = Full Package-temperature Range	200 100	mW
$T_{op}$	Operating Temperature : HCC Types HCF Types	- 55 to + 125 - 40 to + 85	$^{\circ}C$
$T_{stg}$	Storage Temperature	- 65 to + 150	$^{\circ}C$

Stresses above those listed under "Absolute Maximum Ratings" may cause permanent damage to the device. This is a stress rating only and functional operation of the device at these or any other conditions above those indicated in the operational sections of this specification is not implied. Exposure to absolute maximum rating conditions for external periods may affect device reliability.

\* All voltage values are referred to  $V_{SS}$  pin voltage.

## RECOMMENDED OPERATING CONDITIONS

Symbol	Parameter	Value	Unit
$V_{DD}$	Supply Voltage : HCC Types HCF Types	3 to 18 3 to 15	V
$V_i$	Input Voltage	0 to $V_{DD}$	V
$T_{op}$	Operating Temperature : HCC Types HCF Types	- 55 to + 125 - 40 to + 85	$^{\circ}C$

## STATIC ELECTRICAL CHARACTERISTICS (over recommended operating conditions)

Symbol	Parameter	Test Conditions				Value						Unit		
		V <sub>I</sub> (V)	V <sub>O</sub> (V)	I <sub>O</sub>   ( $\mu$ A)	V <sub>DD</sub> (V)	T <sub>Low</sub> *		25°C			T <sub>High</sub> *			
						Min.	Max.	Min.	Typ.	Max.	Min.		Max.	
<b>VCO SECTION</b>														
V <sub>OH</sub>	Output High Voltage	0/ 5 0/10 0/15		< 1 < 1 < 1	5 10 15	4.95 9.95 14.95		4.95 9.95 14.95	5 10 15		4.95 9.95 14.95		V	
V <sub>OL</sub>	Output Low Voltage	5/0 10/0 15/0		< 1 < 1 < 1	5 10 15		0.05 0.05 0.05			0.05 0.05 0.05		0.05 0.05 0.05		
I <sub>OH</sub>	Output Drive Current	HCC Types	0/ 5	2.5		5	- 2		- 1.6	- 3.2		- 1.15		mA
			0/ 5	4.6		5	- 0.64		- 0.51	- 1		- 0.36		
			0/10	9.5		10	- 1.6		- 1.3	- 2.6		- 0.9		
			0/15	13.5		15	- 4.2		- 3.4	- 6.8		- 2.4		
		HCF Types	0/ 5	2.5		5	- 1.53		- 1.36	- 3.2		- 1.1		
			0/ 5	4.6		5	- 0.52		- 0.44	- 1		- 0.36		
			0/10	9.5		10	- 1.3		- 1.1	- 2.6		- 0.9		
			0/15	13.5		15	- 3.6		- 3.0	- 6.8		- 2.4		
I <sub>OL</sub>	Output Sink Current	HCC Types	0/ 5	0.4		5	0.64		0.51	1		0.36		
			0/10	0.5		10	1.6		1.3	2.6		0.9		
			0/15	1.5		15	4.2		3.4	6.8		2.4		
		HCF Types	0/ 5	0.4		5	0.52		0.44	1		0.36		
			0/10	0.5		10	1.3		1.1	2.6		0.9		
			0/15	1.5		15	3.6		3.0	6.8		2.4		
I <sub>IH</sub> , I <sub>IL</sub>	Input Leakage Current	HCC Types	0/18	Any Input	18		$\pm$ 0.1		$\pm$ 10 <sup>-5</sup>	$\pm$ 0.1		$\pm$ 1	$\mu$ A	
		HCF Types	0/15		15		$\pm$ 0.3		$\pm$ 10 <sup>-5</sup>	$\pm$ 0.3		$\pm$ 1		
<b>PHASE COMPARATOR SECTION</b>														
I <sub>DD</sub>	Total Device Current Pin 14 = Open Pin 5 = V <sub>DD</sub>	0/ 5			5		0.1		0.05	0.1		0.1	mA	
		0/10			10		0.5		0.25	0.5		0.5		
		0/15			15		1.5		0.75	1.5		1.5		
		0/20			20		4		2	4		4		
	Pin 14 = V <sub>SS</sub> or V <sub>DD</sub> Pin 5 = V <sub>DD</sub>	HCC Types	0/ 5			5		5		0.04	5		150	$\mu$ A
			0/10			10		10		0.04	10		300	
			0/15			15		20		0.04	20		600	
		0/20			20		100		0.08	100		3000		
		HCF Types	0/ 5			5		20		0.04	20		150	
			0/10			10		40		0.04	40		300	
0/15				15		80		0.04	80		600			
I <sub>OH</sub>	Output Drive Current	HCC Types	0/ 5	2.5		5	- 2		- 1.6	- 3.2		- 1.15	mA	
			0/ 5	4.6		5	- 0.64		- 0.51	- 1		- 0.36		
			0/10	9.5		10	- 1.6		- 1.3	- 2.6		- 0.9		
			0/15	13.5		15	- 4.2		- 3.4	- 6.8		- 2.4		
		HCF Types	0/ 5	2.5		5	- 1.53		- 1.36	- 3.2		- 1.1		
			0/ 5	4.6		5	- 0.52		- 0.44	- 1		- 0.36		
			0/10	9.5		10	- 1.3		- 1.1	- 2.6		- 0.9		
			0/15	13.5		15	- 3.6		- 3.0	- 6.8		- 2.4		

\* T<sub>Low</sub> = - 55°C for HCC device : - 40°C for HCF device.\* T<sub>High</sub> = + 125°C for HCC device : + 85°C for HCF device.The Noise Margin for both "1" and "0" level is : 1V min. with V<sub>DD</sub> = 5V, 2V min. with V<sub>DD</sub> = 10V, 2.5V min. with V<sub>DD</sub> = 15V.

STATIC ELECTRICAL CHARACTERISTICS (continued)

Symbol	Parameter		Test Conditions				Value						Unit	
			V <sub>I</sub> (V)	V <sub>O</sub> (V)	I <sub>O</sub>   ( $\mu$ A)	V <sub>DD</sub> (V)	T <sub>Low</sub> *		25°C			T <sub>High</sub> *		
							Min.	Max.	Min.	Typ.	Max.	Min.		Max.
I <sub>OL</sub>	Output Sink Current	HCC Types	0/ 5	0.4		5	0.64		0.51	1		0.36		mA
			0/10	0.5		10	1.6		1.3	2.6		0.9		
			0/15	1.5		15	4.2		3.4	6.8		2.4		
		HCF Types	0/ 5	0.4		5	0.52		0.44	1		0.36		
			0/10	0.5		10	1.3		1.1	2.6		0.9		
			0/15	1.5		15	3.6		3.0	6.8		2.4		
V <sub>IH</sub>	Input High Voltage		0.5/4.5	< 1	5	3.5		3.5			3.5		V	
			1/9	< 1	10	7		7			7			
			1.5/13.5	< 1	15	11		11			11			
V <sub>IL</sub>	Input Low Voltage		4.5/0.5	< 1	5		1.5			1.5		1.5	V	
			9/1	< 1	10		3			3		3		
			13.5/1.5	< 1	15		4			4		4		
I <sub>IH</sub> , I <sub>IL</sub>	Input Leakage Current (except. pin 14)	HCC Types	0/18	Any Input		18		$\pm 0.1$		$\pm 10^{-5}$	$\pm 0.1$		$\pm 1$	$\mu$ A
		HCF Types	0/15			15		$\pm 0.3$		$\pm 10^{-5}$	$\pm 0.3$		$\pm 1$	
I <sub>OUT</sub>	3-state Leakage Current	HCC Types	0/18	0/18		18		$\pm 0.4$		$\pm 10^{-4}$	$\pm 0.4$		$\pm 12$	$\mu$ A
		HCF Types	0/15	0/15		15		$\pm 1.0$		$\pm 10^{-4}$	$\pm 1.0$		$\pm 7.5$	
C <sub>I</sub>	Input Capacitance		Any Input						5	7.5			pF	

\* T<sub>Low</sub> = -55°C for HCC device : -40°C for HCF device.

\* T<sub>High</sub> = +125°C for HCC device : +85°C for HCF device.

The Noise Margin for both "1" and "0" level is : 1V min. with V<sub>DD</sub> = 5V, 2V min. with V<sub>DD</sub> = 10V, 2.5V min. with V<sub>DD</sub> = 15V.

ELECTRICAL CHARACTERISTICS (T<sub>amb</sub> = 25 °C)

Symbol	Parameter	Test Conditions		Value			Unit	
			V <sub>DD</sub> (V)	Min.	Typ.	Max.		
<b>VCO SECTION</b>								
P <sub>D</sub>	Operating Power Dissipation	fo = 10 KHz R1 = 10 MΩ R2 = ∞ V <sub>COIN</sub> = $\frac{V_{DD}}{2}$	5		70	140	μW	
			10		800	1600		
			15		3000	6000		
f <sub>max</sub>	Maximum Frequency	R1 = 10 KΩ C1 = 50 pF R2 = ∞ V <sub>COIN</sub> = V <sub>DD</sub>	5	0.3	0.6		MHz	
			10	0.6	1.2			
			15	0.8	1.6			
		R1 = 5 KΩ n C1 = 50 pF R2 = ∞ V <sub>COIN</sub> = V <sub>DD</sub>	5	0.5	0.8			
			10	1	1.4			
			15	1.4	2.4			
	Center Frequency (f <sub>0</sub> ) and Frequency Range f <sub>max</sub> - f <sub>min</sub>	Programmable with external components R1, R2 and C1						
	Linearity	V <sub>COIN</sub> =2.5V ±0.3 R1=10 KΩ V <sub>COIN</sub> =5V ±1 R1=100 KΩ V <sub>COIN</sub> =5V ±2.5 R1=400 KΩ V <sub>COIN</sub> =7.5V ±1.5 R1=100 KΩ V <sub>COIN</sub> =7.5V ±5 R1=1 MΩ	5		1.7		%	
			10		0.5			
			10		4			
			15		0.5			
			15		7			
	Temperature Frequency Stability (no frequency offset) f <sub>min</sub> = 0		5		±0.12		% / °C	
			10		±0.04			
			15		±0.015			
	Temperature Frequency Stability (frequency offset) f <sub>min</sub> ≠ 0		5		±0.09			
			10		±0.07			
			15		±0.03			
V <sub>CO</sub>	Output Duty Cycle		5, 10, 15		50		%	
t <sub>THL</sub> t <sub>TLH</sub>	VCO Output Transition Time		5		100	200	ns	
			10		50	100		
			15		40	80		
	Source Follower Output (demodulated Output): Offset Voltage V <sub>COIN</sub> - V <sub>DEM</sub>	R <sub>S</sub> > 10 KΩ	5, 10, 15		1.8	2.5	V	
	Source Follower Output (demodulated Output): Linearity	R <sub>S</sub> =100 KΩ V <sub>COIN</sub> =2.5 <sup>±0.3</sup> V R <sub>S</sub> =300 KΩ V <sub>COIN</sub> =5 <sup>±2.5</sup> V R <sub>S</sub> =500 KΩ V <sub>COIN</sub> =7.5 <sup>±5</sup> V	5		0.3		%	
			10		0.7			
			15		0.9			
V <sub>Z</sub>	Zener Diode Voltage	I <sub>Z</sub> = 50 μA		4.45	5.5	7.5	V	
R <sub>Z</sub>	Zener Dynamic Resistance	I <sub>Z</sub> = 1 mA			40		Ω	
<b>PHASE COMPARATOR SECTION</b>								
R14	Pin 14 (signal in) Input Resistance		5	1	2		MΩ	
			10	0.2	0.4			
			15	0.1	0.2			
	A.C. Coupled Signal Input Voltage Sensitivity * (peak to peak)		f <sub>in</sub> = 100 KHz sine wave	5	180	360		mV
				10	330	660		
				15	900	1800		

## HCC/HCF4046B

### ELECTRICAL CHARACTERISTICS (continued)

Symbol	Parameter	Test Conditions		Value			Unit
			V <sub>DD</sub> (V)	Min.	Typ.	Max.	
<b>PHASE COMPARATOR SECTION (cont'd)</b>							
T <sub>PHL</sub>	Propagation Delay Time High to Low Level Pins 14 to 13		5	225	450		ns
			10	100	200		
			15	65	130		
T <sub>PLH</sub>	Propagation Delay Time Low to High, Level		5		350	700	ns
			10		150	300	
			15		100	200	
T <sub>PHZ</sub>	Propagation Delay Time 3-state High Level to High Impedance Pins 14 to 13		5		225	450	ns
			10		100	200	
			15		65	130	
T <sub>PLZ</sub>	Low Level to High Impedance		5		285	570	ns
			10		130	260	
			15		95	190	
t <sub>r</sub> , t <sub>f</sub>	Input Rise or Fall Time Comparator Pin 3		5			50	μs
			10			1	
			15			0.3	
	Signal Pin 14		5			500	μs
			10			20	
			15			2.5	
T <sub>THL</sub> , T <sub>TLH</sub>	Transition Time		5		100	200	ns
			10		50	100	
			15		40	80	

\* For sine wave the frequency must be greater than 10KHz for Phase Comparator II.



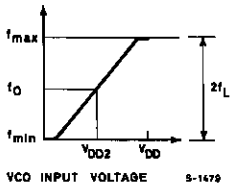
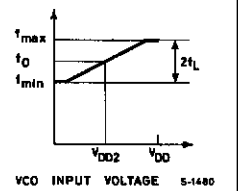
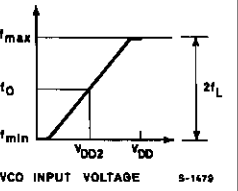
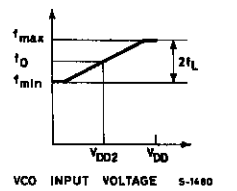
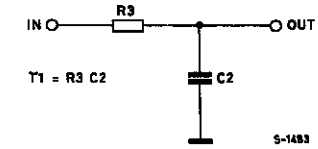
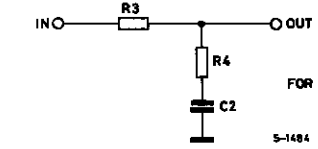
**DESIGN INFORMATION**

This information is a guide for approximating the values of external components for the **HCC/HCF 4046B** in a Phase-Locked-Loop system. The selected external components must be within the following ranges :

$5k\Omega \leq R1, R2, R_s \leq 1M\Omega$

$C1 \geq 100pF$  at  $V_{DD} \geq 5V$

$C1 \geq 50pF$  at  $V_{DD} \geq 10V$

CHARACTERISTICS	USING PHASE COMPARATOR I		USING PHASE COMPARATOR II	
	VCO WITHOUT OFFSET $R2 = \infty$	VCO WITH OFFSET	VCO WITHOUT OFFSET $R2 = \infty$	VCO WITH OFFSET
VCO Frequency				
For No Signal Input	VCO in PLL System will Adjust to centre frequency $f_0$		VCO in PLL System will Adjust to Lowest Operating Frequency $f_{min}$	
Frequency Lock Range, $2 f_L$	$2 f_L = \text{full VCO frequency range}$ $2 f_L = f_{max} - f_{min}$			
Frequency Capture Range, $2 f_C$	 <p><math>T1 = R3 C2</math></p> <p>(1), (2)</p> <p><math>2f_C \approx \frac{1}{\pi} \sqrt{\frac{2T1 f_L}{T1}}</math></p>		$f_C = f_L$	
Loop Filter Component Selection	 <p>FOR <math>2f_C</math> SEE REF. (2)</p>			
Phase Angle Between Signal and Comparator	90° at Centre Frequency ( $f_0$ ), approximating 0° and 180° at ends of lock range ( $2 f_L$ )		Always 0° in lock	
Locks on Harmonics of Centre Frequency	Yes		No	
Signal Input Noise Rejection	High		Low	

\* G.S. Mosktytz "miniaturized RC filters using phase Lockedloop" BSTJ, may 1965

**Plastic DIP16 (0.25) MECHANICAL DATA**

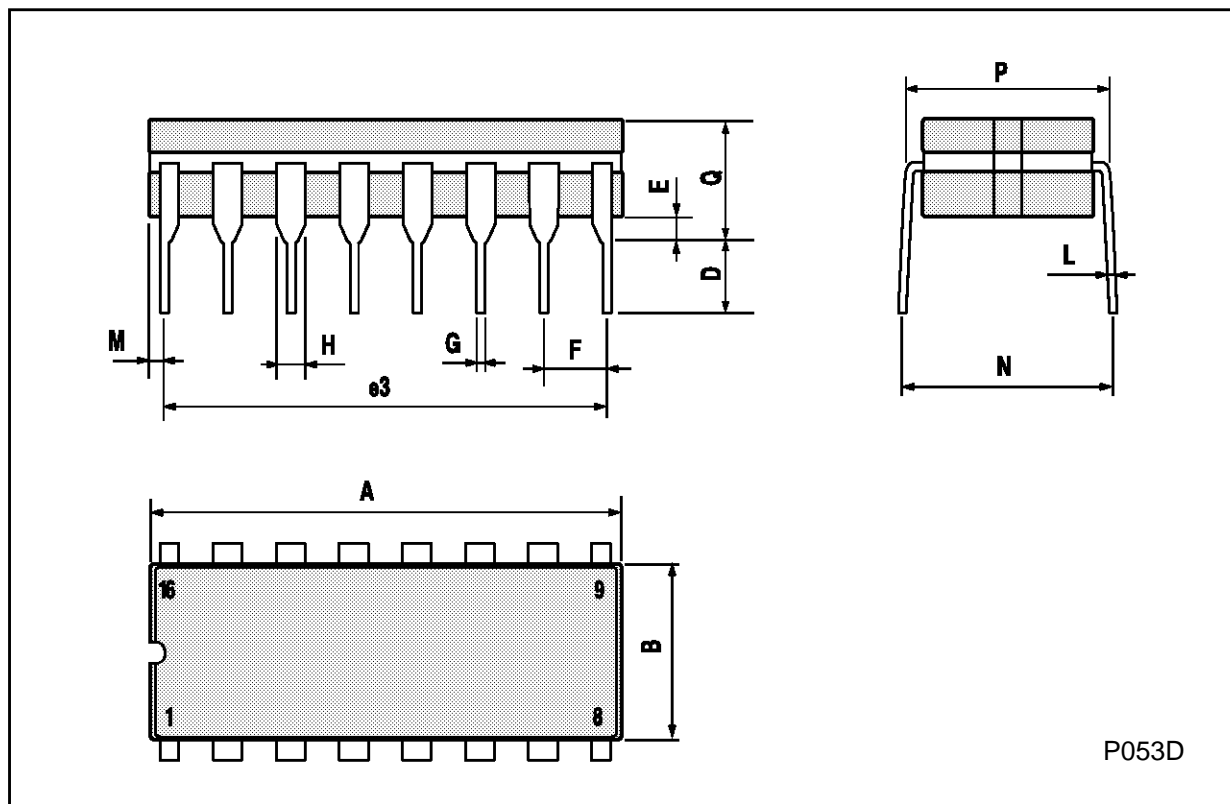
DIM.	mm			inch		
	MIN.	TYP.	MAX.	MIN.	TYP.	MAX.
a1	0.51			0.020		
B	0.77		1.65	0.030		0.065
b		0.5			0.020	
b1		0.25			0.010	
D			20			0.787
E		8.5			0.335	
e		2.54			0.100	
e3		17.78			0.700	
F			7.1			0.280
I			5.1			0.201
L		3.3			0.130	
Z			1.27			0.050



P001C

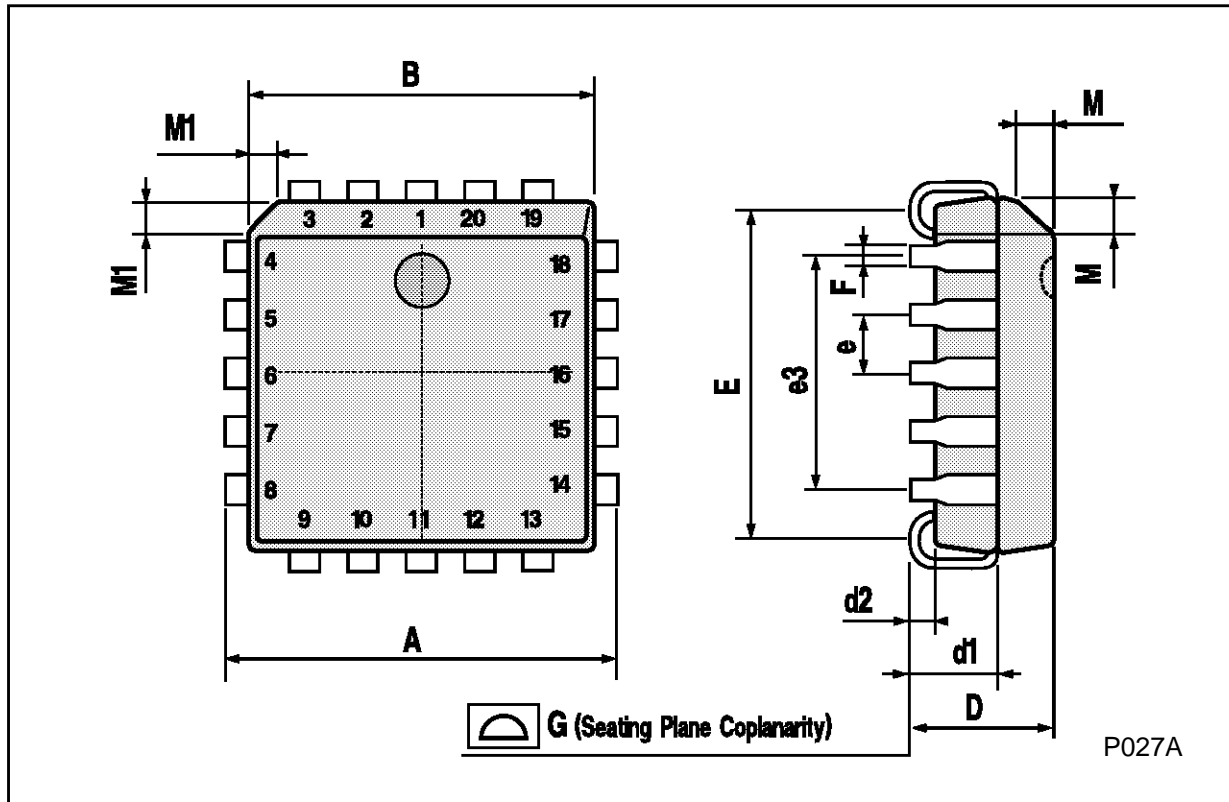
## Ceramic DIP16/1 MECHANICAL DATA

DIM.	mm			inch		
	MIN.	TYP.	MAX.	MIN.	TYP.	MAX.
A			20			0.787
B			7			0.276
D		3.3			0.130	
E	0.38			0.015		
e3		17.78			0.700	
F	2.29		2.79	0.090		0.110
G	0.4		0.55	0.016		0.022
H	1.17		1.52	0.046		0.060
L	0.22		0.31	0.009		0.012
M	0.51		1.27	0.020		0.050
N			10.3			0.406
P	7.8		8.05	0.307		0.317
Q			5.08			0.200



**PLCC20 MECHANICAL DATA**

DIM.	mm			inch		
	MIN.	TYP.	MAX.	MIN.	TYP.	MAX.
A	9.78		10.03	0.385		0.395
B	8.89		9.04	0.350		0.356
D	4.2		4.57	0.165		0.180
d1		2.54			0.100	
d2		0.56			0.022	
E	7.37		8.38	0.290		0.330
e		1.27			0.050	
e3		5.08			0.200	
F		0.38			0.015	
G			0.101			0.004
M		1.27			0.050	
M1		1.14			0.045	



Information furnished is believed to be accurate and reliable. However, SGS-THOMSON Microelectronics assumes no responsibility for the consequences of use of such information nor for any infringement of patents or other rights of third parties which may result from its use. No license is granted by implication or otherwise under any patent or patent rights of SGS-THOMSON Microelectronics. Specifications mentioned in this publication are subject to change without notice. This publication supersedes and replaces all information previously supplied. SGS-THOMSON Microelectronics products are not authorized for use as critical components in life support devices or systems without express written approval of SGS-THOMSON Microelectronics.

© 1994 SGS-THOMSON Microelectronics - All Rights Reserved

SGS-THOMSON Microelectronics GROUP OF COMPANIES

Australia - Brazil - France - Germany - Hong Kong - Italy - Japan - Korea - Malaysia - Malta - Morocco - The Netherlands -  
Singapore - Spain - Sweden - Switzerland - Taiwan - Thailand - United Kingdom - U.S.A