

COMPLEMENTARY SILICON POWER TRANSISTORS

- SGS-THOMSON PREFERRED SALESTYPES
- COMPLEMENTARY PNP - NPN DEVICES

APPLICATIONS

- LINEAR AND SWITCHING INDUSTRIAL EQUIPMENT

DESCRIPTION

The MJE340 is a silicon epitaxial planar NPN transistor intended for use in medium power linear and switching applications. It is mounted in SOT-32.

The complementary PNP type is MJE350.

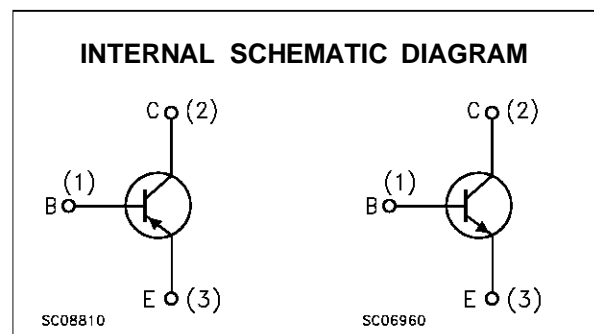
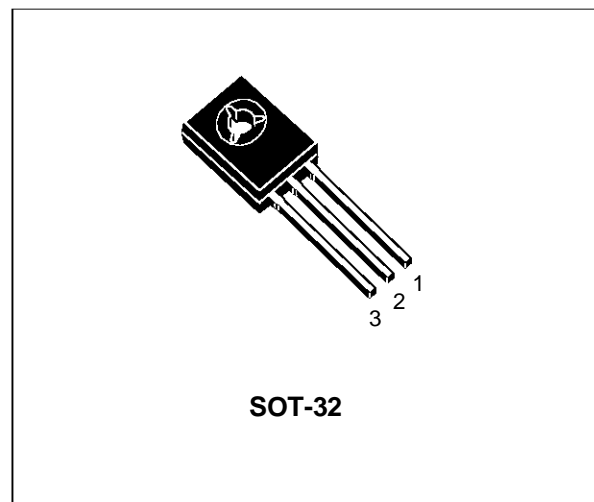

ABSOLUTE MAXIMUM RATINGS

Symbol	Parameter	Value		Unit
		NPN	MJE340	Unit
		PNP	MJE350	Unit
V_{CEO}	Collector-Emitter Voltage ($I_B = 0$)		300	V
V_{EBO}	Emitter-Base Voltage ($I_C = 0$)		3	V
I_C	Collector Current		0.5	A
P_{tot}	Total Power Dissipation at $T_{case} \leq 25^\circ C$		20.8	W
T_{stg}	Storage Temperature		-65 to 150	$^\circ C$
T_j	Max Operating Junction Temperature		150	$^\circ C$

For PNP types voltage and current values are negative.

MJE340 / MJE350

THERMAL DATA

$R_{thj-case}$	Thermal Resistance Junction-case	Max	6.0	$^{\circ}C/W$
----------------	----------------------------------	-----	-----	---------------

ELECTRICAL CHARACTERISTICS ($T_{case} = 25^{\circ}C$ unless otherwise specified)

Symbol	Parameter	Test Conditions	Min.	Typ.	Max.	Unit
I_{CBO}	Collector Cut-off Current ($I_E = 0$)	$V_{CB} = 300 V$			100	μA
I_{EBO}	Emitter Cut-off Current ($I_C = 0$)	$V_{EB} = 3 V$			100	μA
$V_{CE(sus)}^*$	Collector-Emitter Sustaining Voltage ($I_B = 0$)	$I_C = 1 mA$	300			V
h_{FE}	DC Current Gain	$I_C = 50 mA$ $V_{CE} = 10 V$	30		240	

* Pulsed: Pulse duration = 300 μs , duty cycle $\leq 2\%$

Safe Operating Area

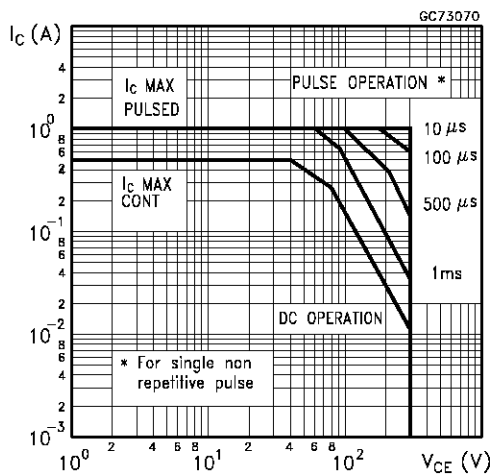

Derating Curve

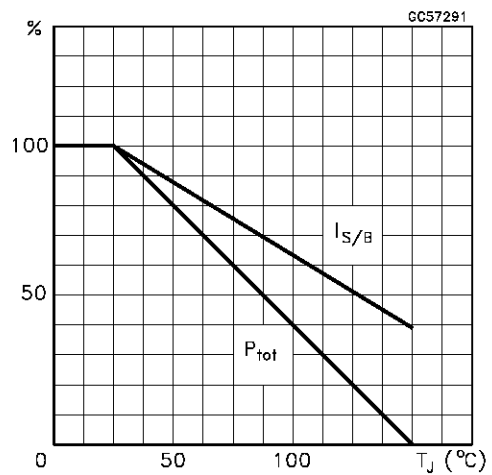

DC Current Gain (NPN type)

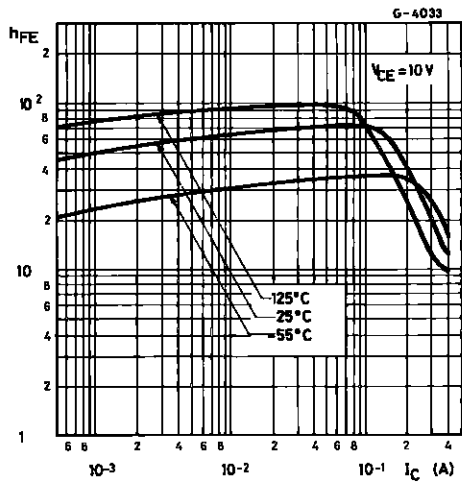

DC Current Gain (PNP type)

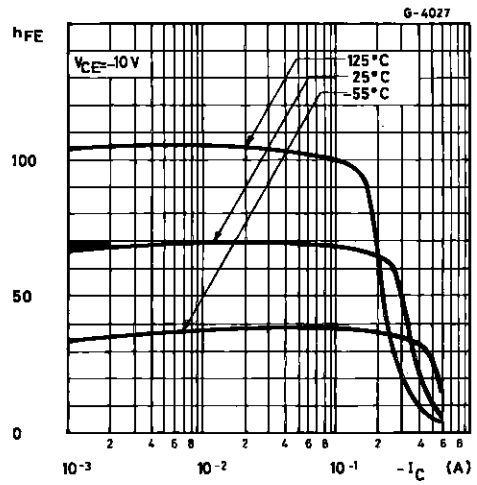

Collector Emitter Saturation Voltage (NPN type)

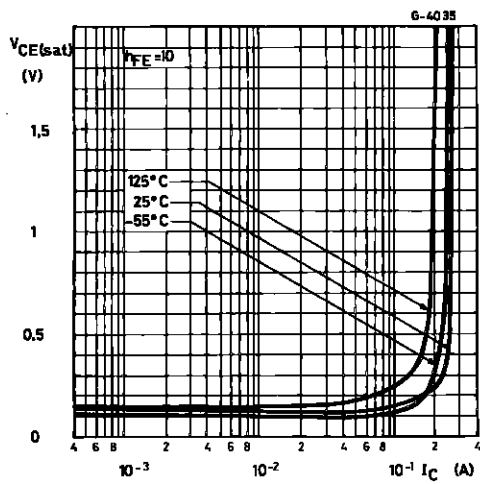

Collector Emitter Saturation Voltage (PNP type)

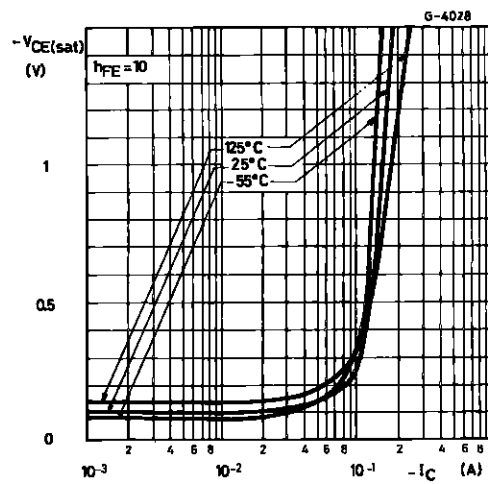

SOT-32 (TO-126) MECHANICAL DATA

DIM.	mm			inch		
	MIN.	TYP.	MAX.	MIN.	TYP.	MAX.
A	7.4		7.8	0.291		0.307
B	10.5		10.8	0.413		0.445
b	0.7		0.9	0.028		0.035
b1	0.49		0.75	0.019		0.030
C	2.4		2.7	0.040		0.106
c1	1.0		1.3	0.039		0.050
D	15.4		16.0	0.606		0.629
e		2.2			0.087	
e3	4.15		4.65	0.163		0.183
F		3.8			0.150	
G	3		3.2	0.118		0.126
H			2.54			0.100
H2		2.15			0.084	

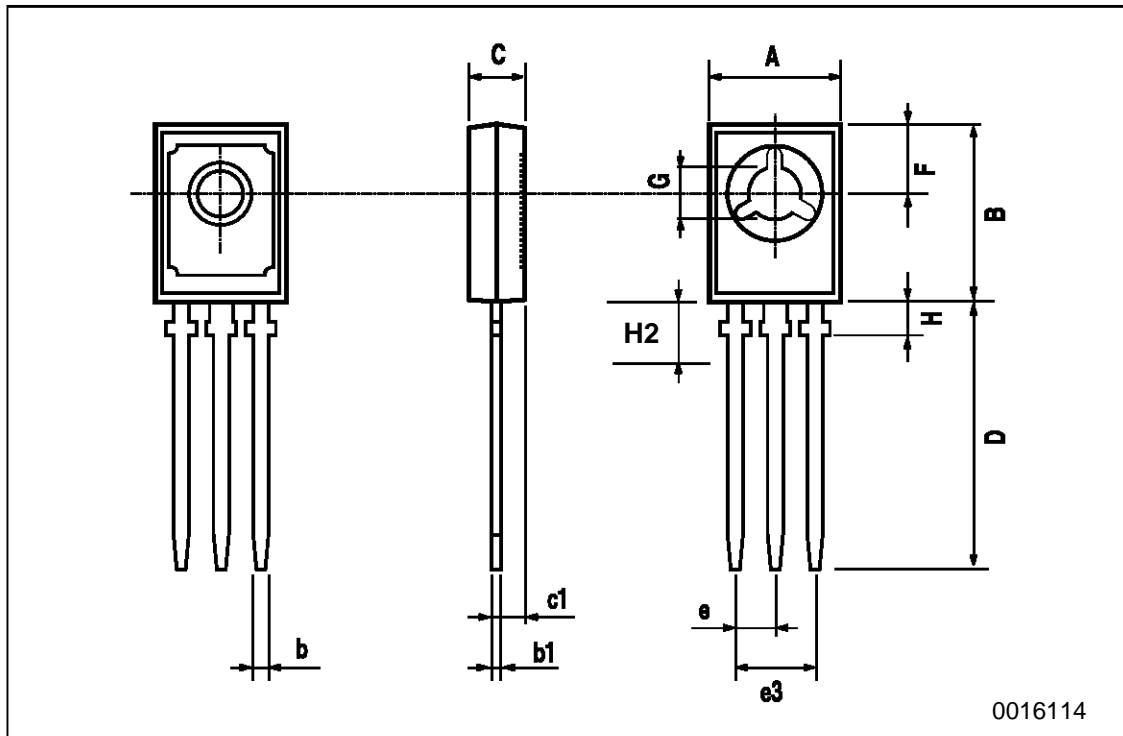

0016114

Information furnished is believed to be accurate and reliable. However, SGS-THOMSON Microelectronics assumes no responsibility for the consequences of use of such information nor for any infringement of patents or other rights of third parties which may result from its use. No license is granted by implication or otherwise under any patent or patent rights of SGS-THOMSON Microelectronics. Specifications mentioned in this publication are subject to change without notice. This publication supersedes and replaces all information previously supplied. SGS-THOMSON Microelectronics products are not authorized for use as critical components in life support devices or systems without express written approval of SGS-THOMSON Microelectronics.

© 1997 SGS-THOMSON Microelectronics - Printed in Italy - All Rights Reserved

SGS-THOMSON Microelectronics GROUP OF COMPANIES

Australia - Brazil - Canada - China - France - Germany - Hong Kong - Italy - Japan - Korea - Malaysia - Malta - Morocco - The Netherlands - Singapore - Spain - Sweden - Switzerland - Taiwan - Thailand - United Kingdom - U.S.A

...